

# Panasonic

ideas for life

PRELIMINARY

Multi-purpose HD Box Camera

1080 / 720 **AK-HC1500**

*With an advanced 14-bit A/D and new digital signal processor  
A high new standard in compact HD cameras*



**M**ULTI FORMAT  
DIGITAL CAMERA SYSTEM



# High performance: Advanced 14-bit A/D and new A compact HD multi-format camera



## Sports relays

Small size and light weight make the AK-HC1500 easy to mount and operate on a pan-tilt head.

## Remote Camera

An economical system suitable for a remote operation.

## Weather information camera

Install in an environmental housing, for an all-weather camera.

## Monitoring and low-light recording

- Ideal for capturing images for use in computer image analysis.
- Exceptionally high sensitivity allows shooting in lighting as low as 0.015 lx\*. \*At max. +68 dB gain

## 14-bit A/D and new DSP provide outstanding functions and image quality

Developed in-house by Panasonic, the advanced digital signal processor provides optimal DTL signal processing for horizontal, vertical, diagonal, dark, and highlight parameters to produce beautiful images with minimal noise. In addition to the usual matrix circuit, the AK-HC1500 has a colour correction function that uses 12-axis independent colour adjustment to provide ideal hue and saturation adjustment of individual colours. Also, a chrominance retain circuit prevents colour de-saturation in highlight areas. The digital signal processor enables processing over a wide dynamic range, minimising saturation in highlights and blocking in dark areas for more detailed expression throughout.



Conventional

Vivid details

## Multi-format capability with new 2/3-inch CCD in a new-standard HD camera

The 1-mega pixel IT-CCD imaging system offers excellent cost-performance, and the 2/3-inch imaging size is ideal for multi-purpose use. This is a true global camera with HD multi-format capability. Compatible with both 720p and 1080i formats, the AK-HC1500 has a high degree of versatility. It prepares you for taking the next step in HD production.

### HD Multi-format support

1080

60i/59.94i/50i/30p/25p/24p

720

60p/59.94p/50p

- This advanced CCD was developed in-house by Panasonic. The improved on-chip lenses and CCD structure achieve a standard sensitivity of F10.0 at 2,000 lx and a smear level of less than -130 dB.

### [CCD Sensitivity]

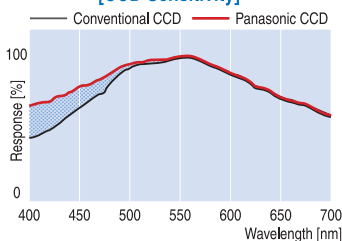

Blue channel sensitivity has been improved approximately 3 dB achieving a better response ratio. Even deep-blue colours can be reproduced with vivid chrominance and significantly reduced noise.

- Panasonic's single-channel transfer system and spatial-offset processing technologies improve signal modulation depth, thus reducing moire.

Output signal gain w/o spatial-offset processing    Output signal gain w/ spatial-offset processing

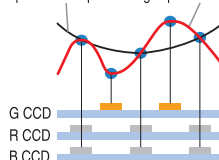

Spatial-offset processing: Green samples are offset, allowing motion in the object to be more faithfully reproduced.

### [Signal Frequency Band]

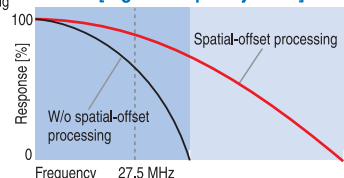

With spatial-offset processing, the depth of modulation of high-frequency signals is greatly improved.



# DSP

The growing trend toward HD is creating demand for global HD camera models. Panasonic's answer is the AK-HC1500, a compact, multi-purpose HD box camera designed for broadcast use. Performance is outstanding thanks to a host of advanced Panasonic technology, starting with a 14-bit A/D and JUPITER, new DSP (digital signal processor). Also new is a high-sensitivity 2/3-inch 1-mega pixel IT-CCD with multi-format compatibility. Excelling in both quality and features, the AK-HC1500 is a high-cost-performance solution in applications ranging from live relays to information gathering.

# ANALYSIS

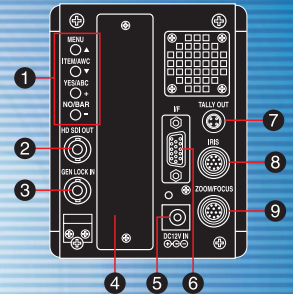

- 1 Menu Control
- 2 HD SDI
- 3 Gen lock
- 4 Option Slot
- 5 DC+12 V
- 6 I/F Mini D-sub15pin
- 7 Tally
- 8 Iris Control
- 9 Zoom/Focus Control

## Features variable frame rate and a cine gamma curve.

The AK-HC1500 debuts as the first multi-purpose camera to feature a variable frame rate function and a cine gamma curve. The variable frame rate allows the overcranking and undercranking speed effects that film cameras provide, and the cine gamma curve reproduces images with a tone similar to film recordings. With the AK-HC1500, you can create productions that closely replicate the cine-like feeling and expressivity of film productions.

- You can vary the number of frames per second (4 fps to 60 fps), just as you can with a film camera. This lets you use the distinctive undercranking and overcranking speed effects of film cameras.
- Thanks to a special cine gamma curve, the CCD can produce pictures with the same kind of tonal beauty, natural gradation and rich colours you get with film recordings.

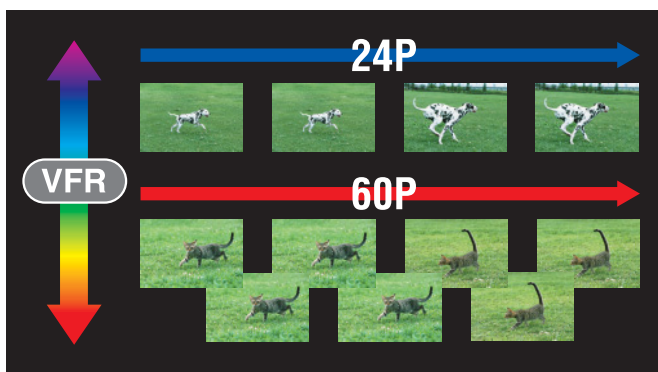

Movies



TV

## Minimizing environmental impacts through low power consumption and a compact footprint.

Fewer parts, low power consumption and a compact design make the AK-HC1500 an environment-friendly choice.

- The AK-HC1500 uses a newly designed CCD drive circuit that requires low power consumption and a DSP that consumes little power.
- Fewer parts are used, and the weights of structural parts have been reduced.
- Small size is a big advantage in cameras used for information gathering, set in a housing, or mounted on a pan-tilt head.

## Yet more features

- Option slot for expansion  
The rear option slot lets you add a variety of equipment, making the AK-HC1500 suitable for use in a wider range of applications and with different kinds of network connections.
  - Mount a down converter, analogue output unit or other equipment.
- Easy-to-use menu buttons

### Example of Remote Camera System

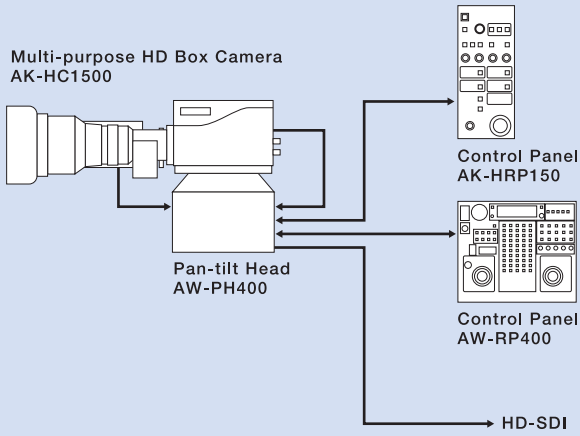

### Example of Multiple Camera System

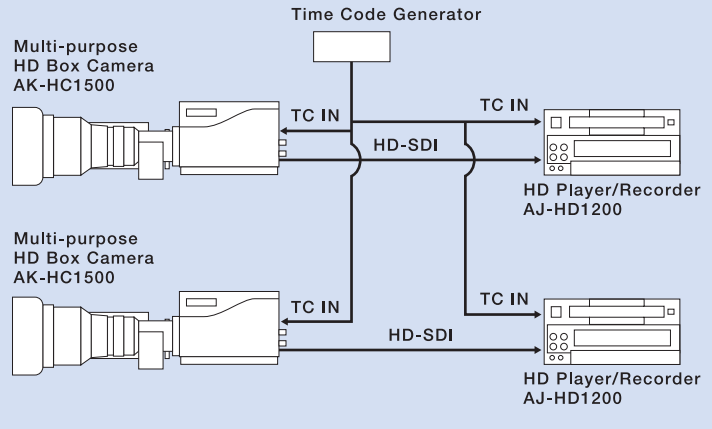

## SPECIFICATIONS

CCD	2/3" 1-mega pixel IT-CCD
Image sensing method	GBR Image sensing method
Total number of pixels	1,370 (H) × 744 (V)
Effective number of pixels	1,280 (H) × 720 (V)
Optical prism	F1.4 Prism
Optical filter	(ND) 100 %, 25 %, 6.3 %, 1.6 %
Lens mount	Bayonet type
Sensitivity	F10.0 at 2,000 lx
Minimum Illumination	0.015 lx (F1.4/68 dB)

Gain	68 dB Max.
S/N	54 dB
Smear	Less than -130 dB
M.T.F.	45 % (27.5 MHz, 720/60p)
Storage temperature	-4 °F to 140 °F (-20 °C to +60 °C)
Operating temperature	32 °F to 104 °F (0 °C to +40 °C)
Power consumption	Approx. 18 W (DC12 V)
Dimensions (W×H×D)	Approx. 3-9/16", 4-10/16", 6-5/16" (90 mm×117 mm×160 mm)
Weight	Approx. 3.5 lbs (1.6 kg)

# Panasonic

Matsushita Electric Industrial Co., Ltd.  
Panasonic System Solutions Company  
Corporate Broadcast and Multimedia Division

4-3-1 Tsunashima-Higashi, Kohoku-ku,  
Yokohama City 223-8639, Japan

<http://panasonic.biz/broad/>

#### [Countries and Regions]

Argentina	+54 1 308 1610	Korea	+82 2 2106 6666	Spain	+34 (93) 425 93 00
Australia	+61 2 9887 6222	Kuwait	+965 481 2123	Sweden	+46 (8) 680 26 41
Austria	+43 (0)1 610 80 773	Lebanon	+961 1 216827	Switzerland	+41 (0)41 259 96 32
Bahrain	+973 252292	Malaysia	+60 3 5549 5422	Taiwan	+886 2 2725 9100
Belgium	+32 (0)2 481 04 57	Mexico	+52 5 488 1000	Thailand	+66 2 731 8888
Bulgaria	+359 2 946 0786	Montenegro, Serbia	+381 (0)26 466 25 20	Turkey	+90 216 578 3700
Brazil	+55 11 3889 4035	Netherlands	+31 73 64 02 577	U.A.E.	+971 4 282201
Canada	+1 905 624 5010	New Zealand	+64 9 272 0100	Ukraine	+380 44 4903437
China	+86 10 6515 8828	Norway	+47 67 91 78 00		+380 44 4903438
(Hong Kong)	+852 2313 0888	Pakistan	+92 5370320 21		[ext. 112]
Czech Republic	+420 236 032 552/511	Panama	+507 229 2955	U.K.	+44 (0) 1344 70 69 20
Denmark	+45 43 20 08 57	Peru	+51 145 29470	U.S.A.	+1 201 348 5300
Egypt	+20 2 3938151	Philippines	+63 2 633 6162		+1 800 528 8601
Finland, Latvia, Lithuania, Estonia	+358 (9)521 52 53	Poland	+48 (22)338 1100		
France	+33 (0)1 49 46 43 59	Portugal	+351 21 425 77 04		
Germany	+49 (0)611 235 401	Puerto Rico	+1 787 750 4300		
Greece	+30 210 96 92 300	Romania	+40 21 211 4855		
Hungary	+36 (1)382 60 60	Russia & CIS	+7 095 258 42 06		
Indonesia	+62 21 801 5666	Saudi Arabia	+966 1 465 0709		
	+62 21 385 9449	Singapore	+65 6270 0110		
Iran	+98 21 2271463	Slovak Republic	+421 (0)2 52 92 14 23		
Italy	+39 02 67 88 449	Slovenia, Croatia, Bosnia, Macedonia	+386 (0)20 76 63 36 57		
Jordan	+961 6 586 1914	South Africa	+27 11 313 1400		
Kazakhstan	+7 3272 504 777				